

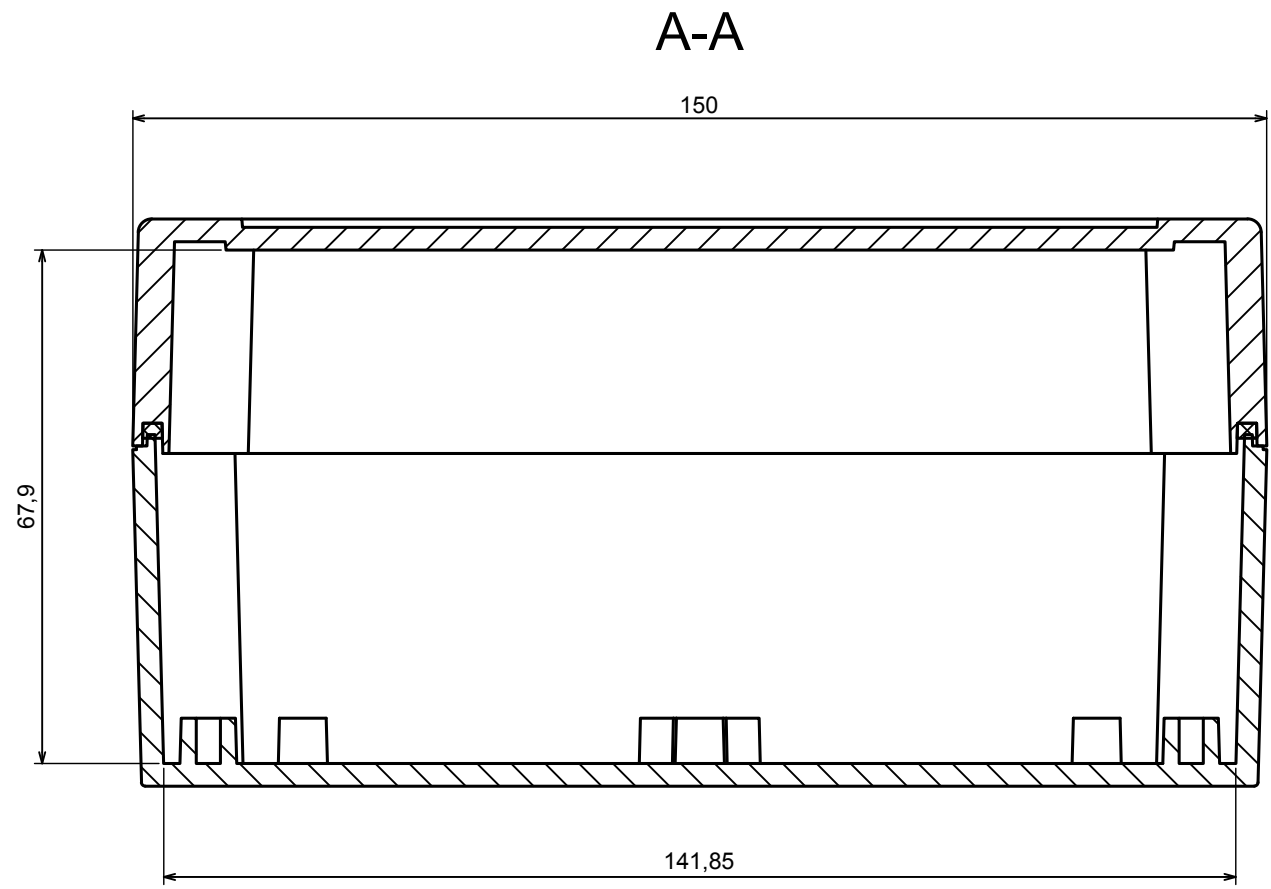

A |



All rights reserved, Copyright Kradex 2020		
Product model	Enclosure ZP150.100.75S TM - Assembly	
Format: A3	Material: PC, ABS	
Scale 1:2	Tolerance: +/- 0.5	

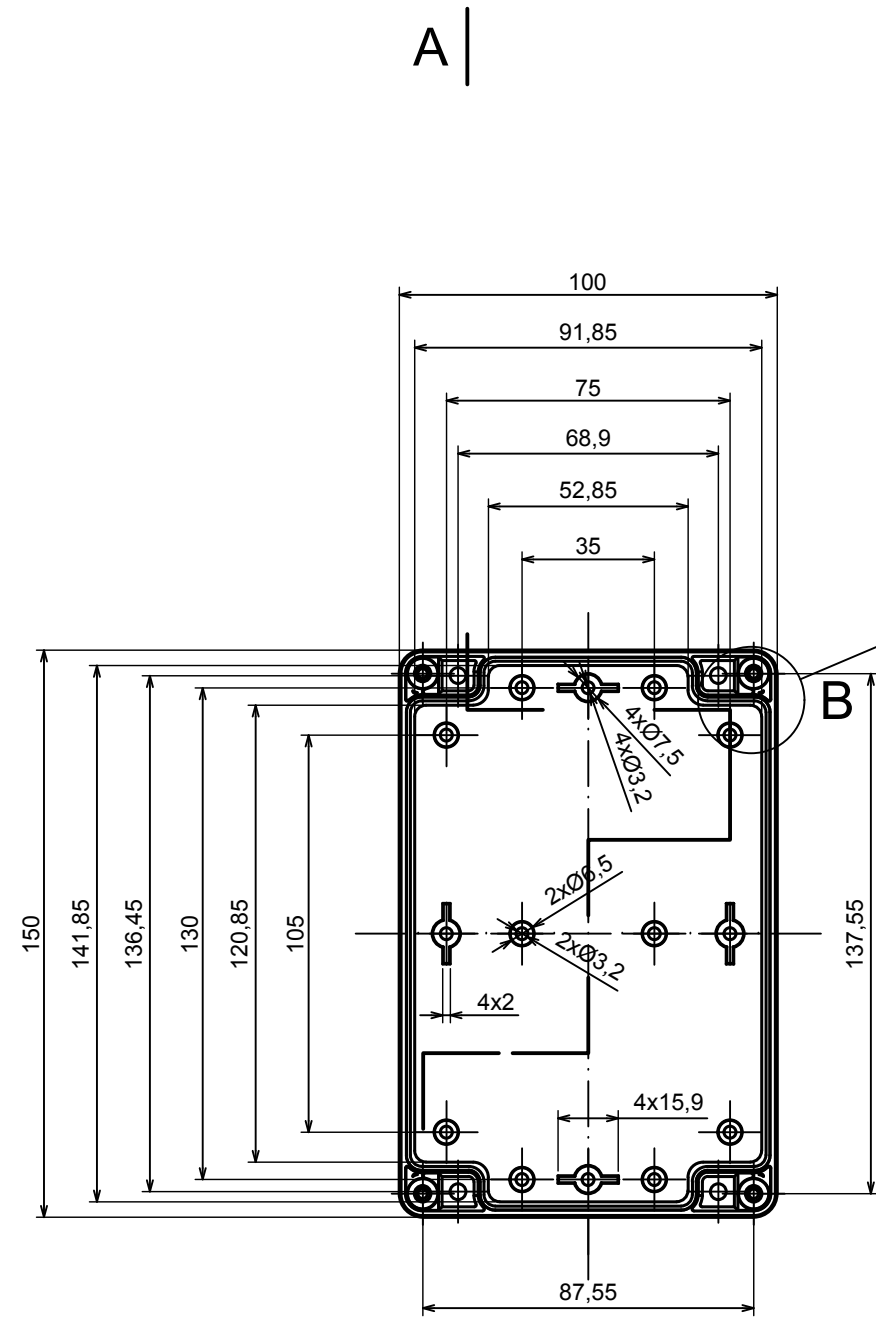

B (1:1)

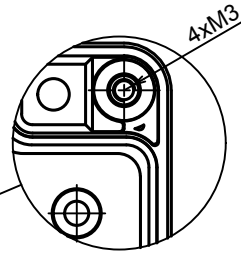

A-A

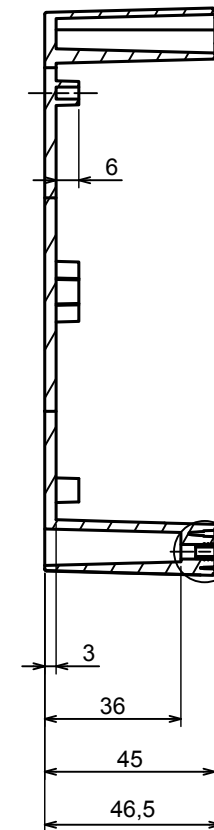

C (1:1)

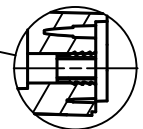

A |

All rights reserved, Copyright Kradox 2020

Product model: Enclosure ZP150.100.75S TM - Base ZP150.100.45 TM

Format: A3 Material: PC, ABS

Scale 1:2 Tolerance: +/- 0.5



A |

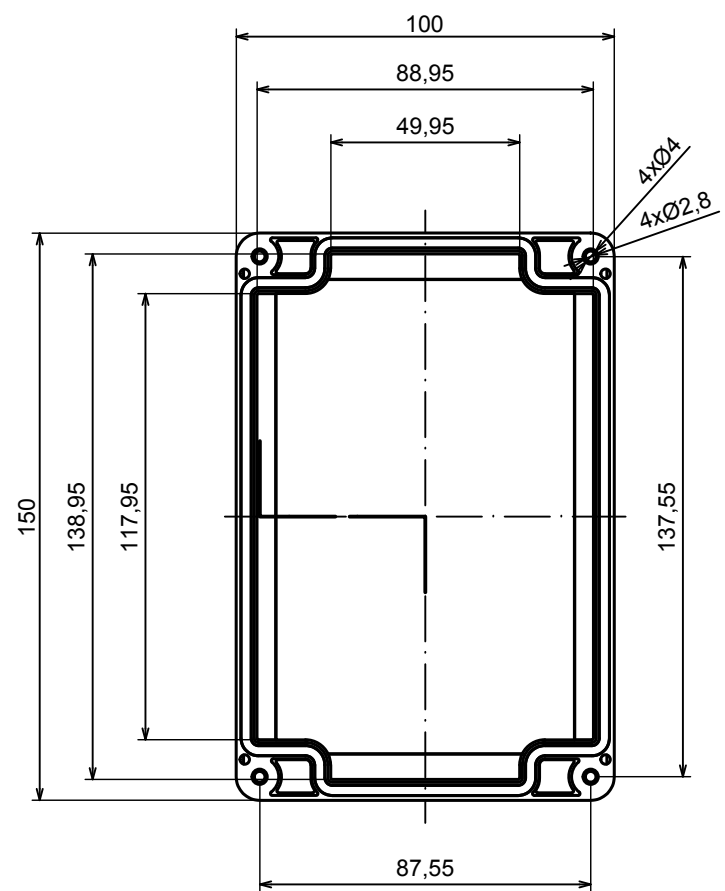

A |

A-A

B (1:1)

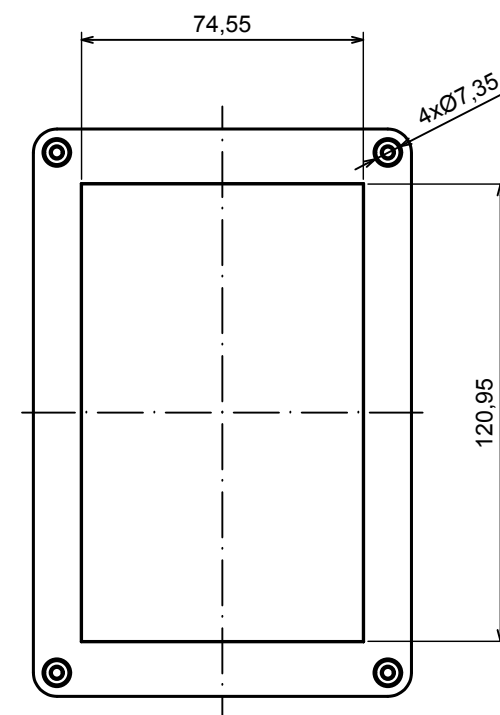
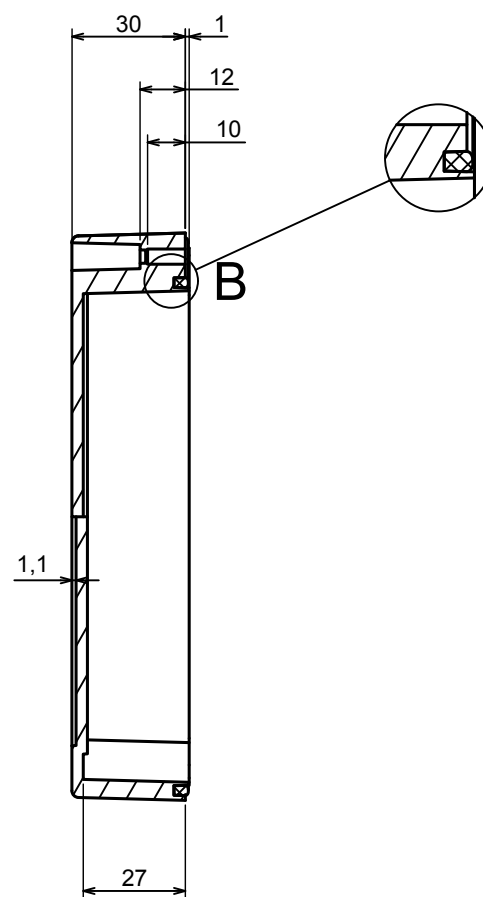

All rights reserved, Copyright Kradox 2020

Product model: Enclosure ZP150.100.75S TM - Cover ZP150.100.30S

Format: A3 Material: PC, ABS

Scale 1:2 Tolerance: +/- 0.5

